

U.S. POSTAGE PAID  
PERMIT #1320  
MENLO PARK, CA. 94025

10:

Andy Korsak VE3FZK/W6  
504 Lakemead Way  
Redwood City CA 94062

RETURN REQUESTED:  
FACDA P.O. BOX 911  
MENLO PARK, CAL.  
94025



AFFILIATED CLUB



AMATEUR RADIO  
STATION W6DTX

VOL. XVIII

1974

# PAARA GRAPHS

PALO ALTO AMATEUR RADIO ASSOCIATION, INC.

MENLO PARK CIVIL DEFENSE RADIO CLUB, K6YQT

Dec. 74

PAARAGRAPHS is the official organ of the Palo Alto Amateur  
Radio Assn., and the Menlo Park C.D. Radio Club.

Volume 18 ----- No. 12 (sniff!) December 1977 -----

PAARA OFFICERS

BOARD OF DIRECTORS

Pres. Fred Canham K6YT Chairman; Fred Canham K6YT  
 V.Pres. Mike Eccles G3PPE/W6 Members: Paul Thekan (NC)  
 Sec'ty Hal Moore W6DEF Andy Korsak VE3FZK/W6  
 Tres. Paul Churchill W6QBY Terry Conboy W6GRZ  
 Trustee W6CTX Fred Canham K6YT Ed Fairbanks W6AIN

MENLO PARK CD RADIO CLUB OFFICERS Tom Ohlsson WB6KQZ

Pres. Fred Canham K6YT

V.Pres. Bob Baum, W6BFH

Sec'ty/Treas. Hal Moore W6DEF

Property Custodian: Ed Fairbanks W6AIN

Assistant: Steve Montoya

Trustee K6IQI and Menlo Park Radio Officer: Bob Allen W6WQD

-----\*\*\*\*-----

POLICIES: Membership includes subscription to PAARAGRAPHS.  
 \$4.00 annually keeps you a Stalwart Member.  
 One (1) Dollar gets you PAARAGRAPHS (monthly)  
 Pay Up Now or Lose PAARA, PAARAGRAPHS and your  
 Immanent Social Status. Yes. Money.

SEND all your goodies (spare rig, cash, booze, XYL, etc.)

TO: PAARA P.O. BOX 911 MENLO PARK CAL. 94025

\*\*\*\*\*

\*\* DA GANG AT PAARAGRAPHS \*\*

Editor-in-Chief: Richard L. ("Da Boss") Ferranti WA6NCX

Cover Artist: Bruce ("Rat-a-tat-tat") Rapp.

Label Making and Mailing: Ed ("The informer") Fairbanks  
 and Paul ("patsy") Thekan, plus the crew.

Ticker tape tinkerer and Shelf Shredder : Guido ("godfather")

Piano Plinker: Debbie ("fingers") Franks / Ferranti

Motley Mouthpiece: Arthur ("machine-gun") Ferranti

Getaway Driver: Dave ("Do it in the road") Waters

Lock-picker and Safe-cracker: Gary ("stilletto") Giampaoli

Head Gun Moll: Anita ("blondie") Enander

\*\*\*\*\*

AN OFFER YOU CAN'T REFUSE: Send me an article, a comment,  
 or nasty note and I'll Print It!! Send goodies to:

Rick Ferranti WA6NCX 1234 Santa Cruz Ave M.P. Ca 94025

415-324-1539

PAARA PICKIN'S \*\*\*\*\* ANNOUNCEMENTS AND JUNK

OUR NEXT MEETING: is the PAARA Christmas Party!!! This is our biggest and best ever -- a real great time is to be had by all. Be sure to look at pages 6 and 7 of this issue for all the dope. It's Friday, December 13, at Sir George's Restaurant in Redwood City. Happy hour starts at 7:00, dinner at 7:30PM. Men can bring a \$1.00 to \$2.00 gift for men, same for the gals, and we'll exchange 'em. Prizes given away, plus a free door prize and raffle. Lotsa goodies for everyone. Bring the wife, the kids, the YL, everyone welcome. Dinner costs about \$3.75 per person. Be sure to come for our best social event of the year -- and share some Christmas cheer and spirits!!!

\*\*\*\*\*

PROGRAM??? Yes, there will be the swearing in of officers, the awarding of the field day plaque, Christmas carols, preposterous speeches, jokes, and a good bar. PAARA thanks the San Carlos Club for their organizational work.

\*\*\*-----\*\*\*

THE BOARD OF DIRECTORS will meet on Wednesday, December 18, at 7:31 $\frac{1}{4}$  PM in the usual white and red PAARA trailer in the SRI parking lot off Ravenswood avenue in Menlo Park. The trailer will be specially decorated for the occasion, with big red letters plastered all over the side, proclaiming "W6OTX" in true Christmas Red. Come (you may even have recovered from the Christmas Party by then!) and help decide what we're going to do with ourselves next year!! Quite fun.

\*\*\*-----\*\*\*

One of the goodies discussed will be the Simulated Emergency Test, held in the last weekend in January. Hal, or E.C., tells me that he'll be dashing off missives to all AREC members about this helpful practice session.

\*\*\*\*\*

AND DON'T FORGET THE PAARA NET: We meet every Monday nite on 145.24 MHz at around 8:15 or earlier. AM, of course. Come and discuss everything other than ham radio, or even see for yourself why PAARA is so loquacious!! Yes.

PAARA PICKIN'S \*\* \*\* ADS AND GONK

FOR SALE: Collins 75A2 Receiver, fine shape, just recently aligned. Ham band only, 1 KHZ linear readout with famous Collins PTO, crystal filter for selectivity from 200 Hz to 6 kHz, with Crystal Calibrator. 160-10 meters. With a speaker, \$150.00. WRITE: Steve Jones WA6CFJ, Star Route Box 44, Woodside, California. 94062.

\*\*\*-----\*\*\*

WANTED: A good novice receiver. Call Sam Black, WN6GPI, 248-5952 eves., or 965-5218 daytime.

----\*----

PAARA would like to thank Sy Stein, WA6ROM, for a fine presentation of the Other Side of the Moon. His slides, movie, and lecture were first rate. Thanks for your program, Sy.

\*\*\*-----\*\*\*

United Airlines' Newsletter carried the following note on October 25: "OFF TO LAUNCHING: One of the most unusual occupants ever carried by United was recently boarded at Lullies International Airport and flown to Los Angeles. It was a 150-pound satellite, which traveled securely strapped in a DC-10 coach seat. The satellite was built by the Amateur Satellite Corporation of Maryland for 'piggyback' launching on a larger satellite of the National Aeronautics and Space Administration". Sounds like OSCAR-7, up and working!

\*\*\*\_\*\*\*

Silent Key Milt Donovan W6MFN left a tower to be taken down. The tower was picked up by Jerry W6OJE and beam by Fred K6YT. But we still gotta take it down! Saturday, December 7 is the day to show up at Milt's house, 209 Oregon Avenue (near the expressway) at 10:00 A.M. Come and help take down an old friend's antenna equipment.

\*\*-----\*\*

Fred Canham, K6YT, has some more closer-tolerance crystals for the beloved PAARA net, right there on 145.24 mHz. These 8 mHz rocks can be had through negotiations with Fred via PAARA net, Ma Bell, P.O. Dept, or Xmas Party!

MORE PAARA PICKIN'S AND GOODIES

Did you know that membership in the ARRL is going up to the horrendous figure of \$9.00 on Jan 1?? You can still subscribe now for \$7.50 per year for any number of years in advance. AND if you subscribe via PAARA (i.e. send a check to Hal Moore via PAARA box 911) then we get to keep a generous \$\$\$000.50¢ cash money! So send in your new subscriptions to QST NOW!!!

\*\*\*-----\*\*\*

Speaking of memberships in ARRL organizations -- don't forget good old PAARA come the first of the year. It's still only \$4.00 for the whole schmer -- and by god PAARAGRAPHS alone is worth the price, right? I think so, anyway. But please, no anonymous posty-cards. No. We got a beautiful postcard (printed in England but postmarked from Menlo Park) which said "please send membership information -- thank you" and that was all she (he) saw fit to write. The Anonymous writer strikes again!! Oh, well, it was a nice card...

\*\*\*-----\*\*\*

Here's the scoop on our financial windfall from the PAARA AUCTION RESULTS, 1974

Net from auction:	\$176.90	
Flea Market	50.46	
Swap Tables	39.25	
Raffle Tickets	89.00	
Refreshments	38.29	de Paul, W6QBY
TOTAL	<u>\$393.90</u>	

To Ye Noble Editor's knowledge, this is the best we've ever done! Thanks to one and all for helping us.

\*\*\*\*\*

Big News Item: W6QBY recently took and somewhat to his amazement passed the test for Advanced Class and recently received the advanced ticket in confirmation. Nice going, Paul -- how many others have recently gone up in the world of ham radio??

\*\*\*\*\*

At the last meeting, Mike Eccles, G3PPE/W6, introduced his wife as a "limey". To which Astute Anita added that Andy Korsak was not a limey, but more properly a lemon.

PAARA WISHES ALL A .....



MERRY  
CHRISTMAS

AND  
A



HAPPY  
NEW

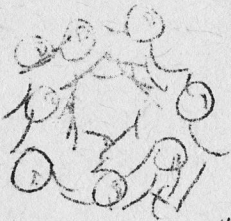

YEAR

AND BE SURE TO SPREAD SOME CHEER AND GOOD CRISTMAS SPIRIT  
AT HOME AND ESPECIALLY AT THE 1974 CHRISTMAS PARTY!  
HERE'S A GOOD TASTE MAP OF WHERE SIR GEORGE'S IT "AT":

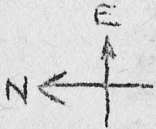

BAYSHORE	WOODSIDE RD.
BROADWAY	SHIPPING CENTER
	X SIR GEORGE'S

AND BE SURE TO COME TO OUR .....



1974

- ANNUAL -

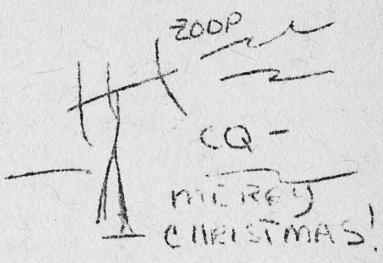

\* CHRISTMAS

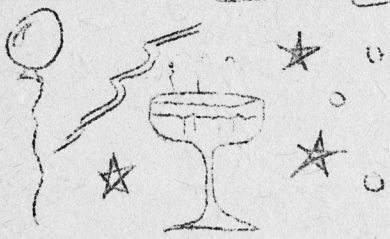

PARTY!!! \*

WOW!! BOFFO!!

THE PLACE: Sir George's Restaurant (see map on opposite pg.)  
Corner of Woodside Road and Broadway, Redwood City

THE TIME: Happy Hour (that means there will be a BAR) starts at 7:00 PM, and dinner starts at 7:30PM (that means there will be FOOD). Approximate cost of the dinner is only \$3.75 per person.

BE SURE: To get into the spirit of things and bring a small (\$1.00 to \$2.00) gift for your own SEX. This is a racy statement, but 100% True. Guys will swap their Gonk with other guys, and gals with gals. You don't have to bring a goodie, but then don't expect one! Besides, its always good to give and get a cutesy little dumb thing in return. Yes.

SO COME on down to Sir george's on FRIDAY NITE, DECEMBER 13, and bring the XYL, kids, girlfriends, XYL2B's, presents, money, etc.

MERRY CHRISTMAS TO ALL

HAPPY NEW YEAR

COME ENJOY YOURSELF WITH PAARA

MINUTES OF THE PAST TWO MEETINGS

Minutes of the Board meeting Wednesday, October 23, 1974.  
Meeting was called to order by Fred, K6YT and 1953 PDT.

Seven members present with two visitors.

Old Business: Decided to buy two safety belts at \$17.00 each from Link, 1081 Aron St., Cocoa, Florida, 32922. This is shown on Page 170 of Oct. QST. Fred will purchase same.

We were all reminded of the Sweepstakes Contest.

We also got \$5.00 each for two 450 mHz transmitters from WB6WNI, the poor guy who was crazy enough to buy them. Similarly, we received \$5.00 from WA6NIL, for a dial.

New Business:

Club crystals on order and will arrive soon. Our net meets on 145.24 mHz instead of 145.224 mHz, got it? Efforts should be made to keep frequencies closer together, esp. since Ye Noble Editor gets sore fingers from tuning everyone across two meters. Discussion of confusion and lack of order on net.

Decided to make a list in alphabetical order of check-ins and to have a net control station to maintain order. List to be published in PAARAGRAPHS. (Oh yeah?..Ed.)

\*\*\*\*-----\*\*\*\*\*

AT the meeting of November 1, 1974, new officers were elected, to be published on page 2 of PAARAGRAPHS next month.

Fred K6YT appointed Steve Stuntz K6FS as the representative from our club to Doc Gmelin's annual Director's meeting. Will be held on December 7, at 9:00AM, at the San Jose Red Cross Chapter Haouse, 333 McKendrie St. San Jose.

Mention was made of the Christmas Party, sponsored by the San Carlos Club. All decided to come!

\*\*\*-\*\*\*

BOARD MEETING AT W60TX TRAILER, WEDNESDAY, NOVEMBER 7, 1974.

Nine members were present. We discussed the first meeting in January and thought it should be a Civil Defense Communications Meeting because of the SET which occurs in the last weekend of January. A couple of possibilities were discussed as speaker and the E.C. will contact same, making a report on the PAARA net. The SET was discussed, with motion made, seconded, and con't....



PAARA meeting minutes con't...  
 approved that the Emergency Coordinator be paid up to \$25.00 for the letter that is always sent to AREC members. There are presently 96 members in the AREC for PAARA. The Annual Christmas Party was discussed. Motion made, seconded and approved that suitable matching funds be paid to the San Carlos Club to help pay for the party. Discussion led by Fred K6YT on the power generator which we used all last Field Day. It apparently needs a new oil shield. Will have further reports and get a new one. An effort will be made to get all the membership to PAY their dues on or by January. This means YOU. The treasurer will get up a roster showing all paid members. Discussion whether or not the list should be sent out with PAARAGRAPHS. No decisions made. It was decided that the Club not need a new Call Book. The illimitable Andy Korsak made a report on the antennas at the trailer, giving SWR of each one on various bands. Result: They're OK but don't expect Hot DX. Discussion on the Club two meter frequency. It should be 145.24 mHz, not 145.224 mHz. (Doesn't make much diff to a Gonset I!!) 73, Hal W6DEF Sect'y

\*\*\*\*\*

1974 ARRL AND PAARA SWEEPSTAKES RESULTS

CW Sweepstakes Results, submitted by Terry Comboy, WB6GPZ

<u>CALL</u>	<u>SCORE</u>	<u>CONTACTS</u>	<u>HRS.</u>	<u>SECTIONS</u>
W6BFH	32	4	2.5	4
W6DEF	96	8	1.7	6
WB6JFH	390	15	9.2	13
K6EER	1224	34	5.0	18
WB6GRZ	1900	38	5.0	25
G3PPE/W6	2760	60	4.0	23
W6AIN	6510	93	15.9	35
K6YT	26660	215	22.0	62
TOTAL	39572	467	65.3	186

While Ye Noble Editor refrains from talking with the olde code key, the Sweepstakes contest was a lot of fun -- especially since the PHONE portion is on the next page. A long wire out the dorm ain't half-bad!

ARRL NOVEMBER SWEEPSTAKES RESULTS \*\* PHONE

Submitted by Jerry WA6LIJ

<u>Name</u>	<u>Call</u>	<u>QSO's</u>	<u>Sections</u>	<u>Points</u>	<u>Pwr</u>	<u>Hrs.</u>
Rick Ferranti	WA6NCX	45	24	2100	A	2.0
Lee Zalaznik	WB6BJB	153	44	13464	A	18.0
Jerry Wagstaffe	W6NIR	191	59	22538	A	16.5
Paul Churchill	W6QBY	229	59	27022	B	12.1
Jerry Starkey	WA6LIJ	301	66	39732	A	20.8
TOTALS		919		104916		

We didn't exactly approach the speed of light with the number of points but it was much fun. 73, Jerry WA6LIJ

\*\*\*\*\*

SATURDAY, Oct. 26, the SPECS (South Peninsula Emergency Communications System) Net provided communication for the March-of-Dimes Walk-a-Thon for the second year. Walt, W6ASH, coordinated the effort, with K6YT as Net Control Station and Paul, WB6GNM, as ANCS. Guest operator at K6YT was Tammy Billik, WN6DMO, who did an efficient job as net control. Manning other check points along the way were Sy, WA6ROM, Jerry, WA6LIJ, "Doc", WB6JPQ; Hal W6DEF, Alva WA6JCU and Jerry and Jean, W6OCP and WB6ISN. About 400 walkers turned out. Thanks to all who participated.

\*\*\*\*\* de W6ASH and FARS

INTERESTED IN 220 MHz (before the CB'ers get it?)

220 REPEATER: Amateurs in the San Francisco Bay Area who are interested in 220 MHz work, will be interested to learn of the existence of what is now known as Root 220, a repeater on that band sponsored by Bay-Com, WR6ABH and Gene Root, WB6000. The group invites any interested amateur to take part in the repeater operation which soon will be operating from three well-situated mountain-top locations. Main frequency is 222.02 in and 223.62 out from a machine on top of Mt. Umunum, south of San Jose. For those who do not have any 220 MHz equipment, there is equipment available at nominal cost complete with crystals and pre-tuned. For further information contact Lance Ginner, K6GSJ in Los Altos.

de CCRC Circle, Nov.74

\*\*\*\*\*

JOIN UP WITH PAARA AND JOIN IN THE FUN!!!

ANOTHER PAARAGRAPHS RIP-OFF! (Or, why won't anyone send me an original circuit schematic????)  
BE the first on your block with a genuine 100% certified CODE PRACTICE OSCILLATOR.

NO shoddy inductors.

NO messy gassy tubes.

NO dangerous, unhealthy High Voltage. YES!

(Maybe YeNoble Editor can use it to get past his degenerated 10.536 WPM code speed -- YOU CAN TOO!)

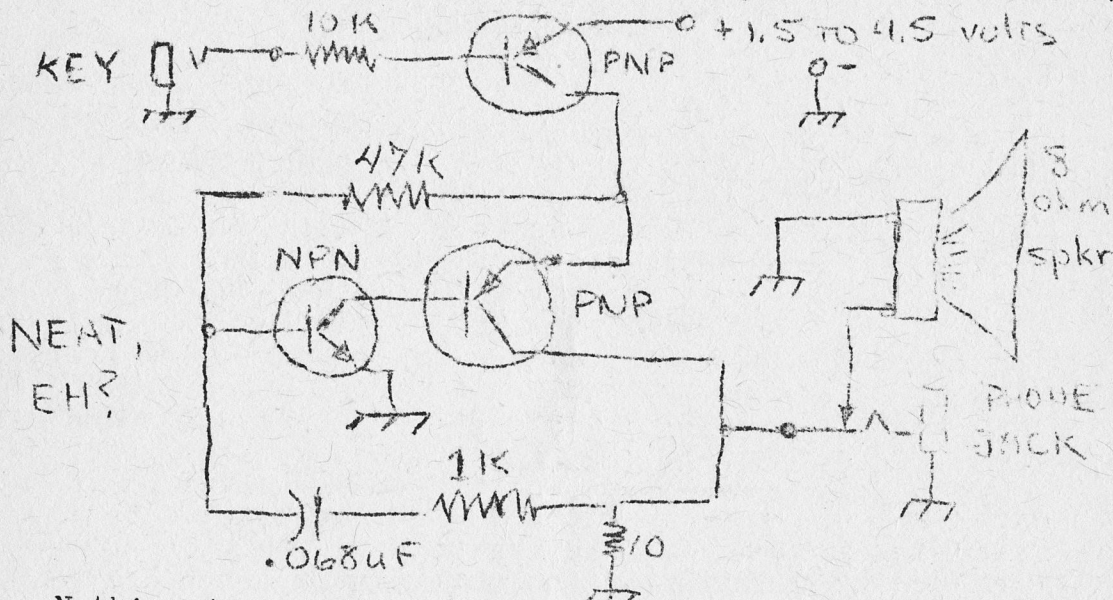

Nothing is critical (including the speaker).  
The PNP transistors can be anything, TO-3 power diamonds work about the best. (2 required)  
The NPN transistor can be any small-signal goodie.  
Change the .068 uF capacitor to alter the tone.

Would make a good Christmas Present for the XYL  
(just what she always wanted)

de THE HAM GAZETTE via the FOOTPRINT.

\*\*\*\*\*

This fabulous issue of PAARAGRAPHS was written on a cool Saturday the 30th of November whilst listening to Bouncy Baroque music and playing with my Mod.19 RTTY.

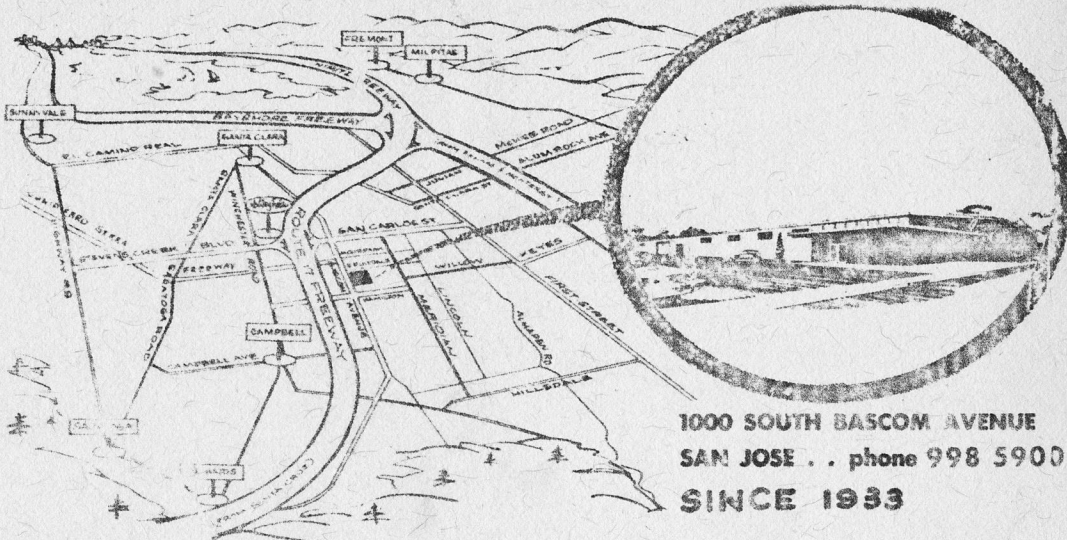

1000 SOUTH BASCOM AVENUE  
 SAN JOSE . . phone 998 5900  
 SINCE 1933

SWE-2

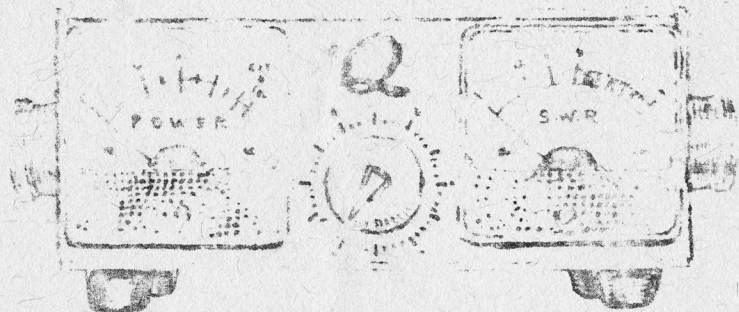

\$22.95

SWR BRIDGE RECTS FORWARD & REFLECTED POWER  
 SIMULTANEOUSLY 'EASY READ' METERS SIZE 5X2X2  
 DUAL 100-MICROAMP METER MOVEMENTS  
 LOW INSERTION LOSS MAY BE LEFT IN LINE UP TO 2,000 WATTS'

*All roads lead to Quesent Electronics*

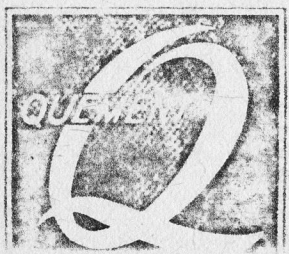

40,000 SQ. FT. OF ELECTRONIC PARTS,  
 COMPONENTS, TUBES AND ACCESSORIES.  
 • ANTENNAS • NEW SERVICE DEPT.  
 • HAM GEAR • ACOUSTIC SOUND DEMONSTRATION ROOM  
 • CITIZEN'S BAND • COMPLETE STEREO HI-FI SET.  
 • COMMERCIAL AND INDUSTRIAL PARTS SUPPLY  
 • BANKAMERICARD • FIRST NATIONAL • MASTERCARD

3 TO 150 MHZ  
 ADD \$1.25 FOR POSTAGE

1000 SO. BASCOM AVENUE, SAN JOSE 998-5900